

Linear Ball Spline

C-Lube Linear Ball Spline MAG
Linear Ball Spline G



Excellent features of compact linear structure by **four-points contact in**

ball spline realized by a simple **two-row raceways**

IKO Linear Ball Spline is a linear motion rolling guide in which an external cylinder makes linear motion along the spline shaft. Since the structure lets a ball to rotate on the spline track groove, it can receive not only the radial load but also rotating torque. Therefore it best fits the structure in which torque transmission and linear motion take place in parallel.



High rigidity despite of compact size

The structure places large diameter balls in two rows and has four-point contact with the track, allowing greater rigidity and compact design.

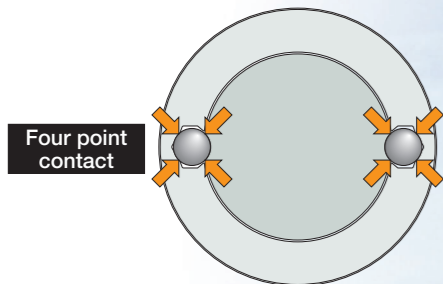

For the load from all directions it gives a good balance and high rigidity!

Allows high accuracy and accurate positioning

Preload removes the clearance along the rotation direction, allowing accurate positioning along the rotation direction.

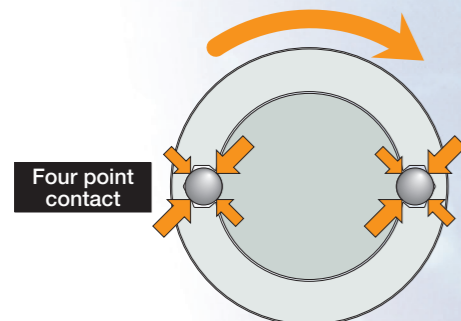

No play along the rotation direction!

Low frictional resistance and smooth motion

The optimum design based on the thorough analysis of ball recirculating route realized low frictional resistance and smooth linear motion durable for high speed operations.

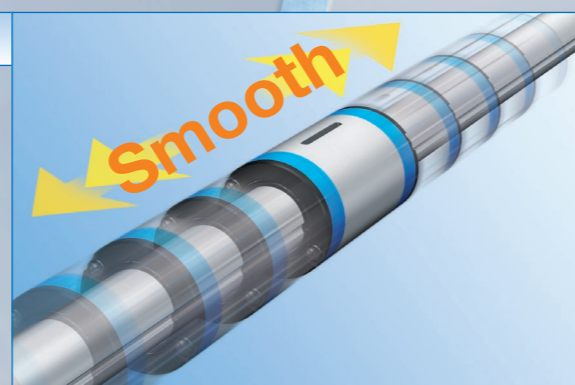

Both high speed durability performance and maintenance free performance are achieved

C-lube Linear Ball Spline MAG realizes a long term maintenance free using the built-in lubrication parts C-Lube for ball recirculation way in external cylinder. Since the lubrication oil inside C-Lube maintains the lubrication performance for a long time, it reduces the annoying lubricating management works and also allows total system cost saving by reducing the oil supply structures.

Durability test assuming the chip mounter

《Test conditions》

Lubrication conditions	Only lubrication oil inside C-lube, with no pre-packed grease	
Test method	Vibration test machine	
Operation condition	Posture	Vertical
	Maximum velocity	860 mm/s
	Acceleration	10 G
	Number of cycle	18.2 Hz
	Stroke length	15 mm

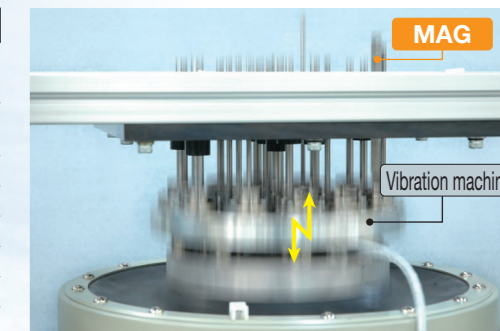

《Result》

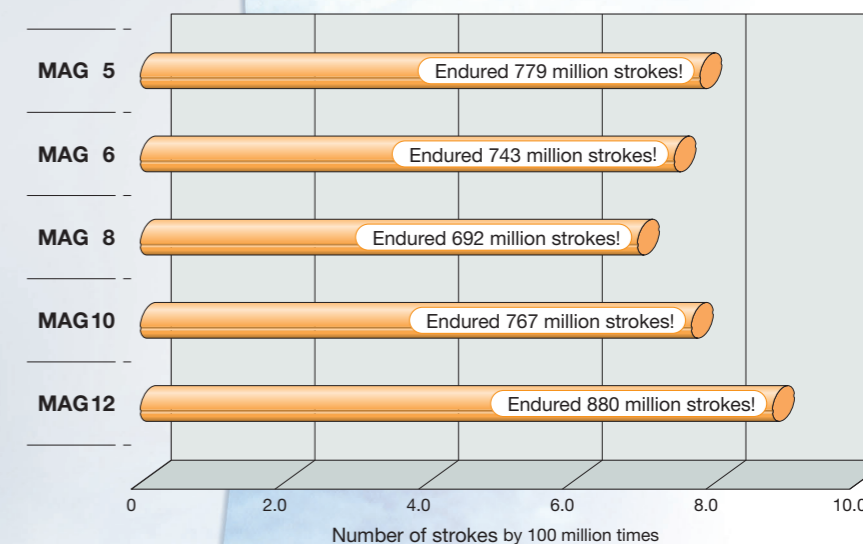

Endured total strokes of 200 million times without a problem, only by lubrication oil inside C-Lube, for vertical shaft and super high tact operation!
Realized the maintenance free of 10 years of use equivalent to 10 years, in the test condition assuming the use for general chip mounters!!

Achieved maintenance free of **more than 600 million total strokes** in this severe operation conditions!!

Free combination is enabled for model/accuracy/preload!!

Extreme interchangeable system

Interchangeable specification

Interchangeable specification allows for external cylinder and spline shaft dimensions to be strictly managed based on unique advanced processing technology, resulting in an unparalleled level of interchangeability. This allows external cylinders and spline shafts to be handled independently and selected in any combination, allowing you to order just what you need, when you need it, and in the quantity you require.

Requirements of ;	Interchangeable specification realizes ;
<ul style="list-style-type: none"> Wish to improve the rigidity and life of machines Wish to improve the accuracy of machines Wish to replace the external cylinder immediately There are not enough external cylinders Wish to replace the spline shaft immediately The length of spline shaft is not sufficient Wish to store only the external cylinders in stock for emergency 	<ul style="list-style-type: none"> Wish to prepare for a sudden design change Wish to select freely the combination of high accuracy and preload Independent handling of external cylinders and spline shafts Free and independent combination of external cylinders and spline shafts Compactness - independent storing of external cylinders and spline shafts

Select the products as many as you wish.

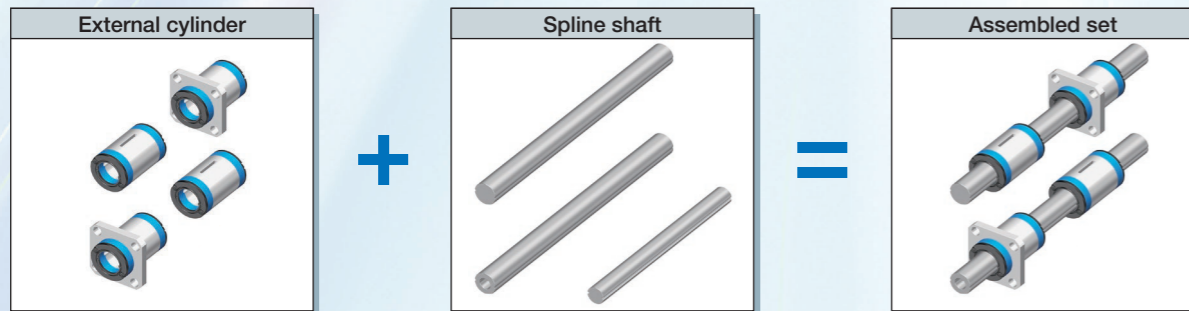

External cylinder interchangeability

A wide variety of models with different sectional shape and length are provided, for free replacement on the same spline shaft.

External cylinder interchangeability	Spline shaft interchangeability						
<p>Shape of external cylinders</p> <table border="1"> <tr> <td>Standard type</td> <td>Flange type</td> </tr> </table> <p>Length of external cylinder</p> <table border="1"> <tr> <td>Standard</td> <td>Long</td> </tr> </table>	Standard type	Flange type	Standard	Long	<p>Spline shaft</p> <table border="1"> <tr> <td>High carbon steel spline solid shaft Stainless steel spline solid shaft</td> <td>High carbon steel spline hollow shaft</td> </tr> </table>	High carbon steel spline solid shaft Stainless steel spline solid shaft	High carbon steel spline hollow shaft
Standard type	Flange type						
Standard	Long						
High carbon steel spline solid shaft Stainless steel spline solid shaft	High carbon steel spline hollow shaft						

C-Lube Linear Ball Spline MAG
Linear Ball Spline G

Any combination of external cylinders and spline shafts can be selected!

Accuracy interchangeability

The simple structure of four-contact in two-row raceway yields small manufacturing errors or accuracy measurement errors, allowing the maintenance of each raceway in the high dimensions accuracy. Two accuracy classes of ordinary and high level are provided, to support even high traveling accuracy purposes.

It allows the accuracy improvement of units without design changes!

Preload interchangeability

The simple structure is leveraged to allow dimensions to be managed with high accuracy, for preloaded external cylinders that are interchangeable. It supports the applications requiring the rigidity of one higher rank.



It allows the rigidity improvement of units without design changes!

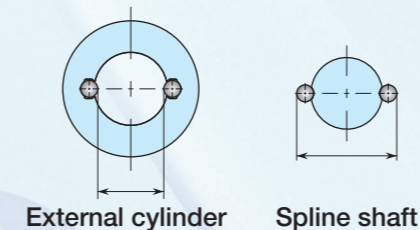

Maintenance free is achieved only by replacing the external cylinder!

By exchanging the external cylinder of Linear Ball Spline MAG of interchangeable specification with an external cylinder of C-Lube Linear Ball Spline G, you can achieve the maintenance free without changing the spline shaft.

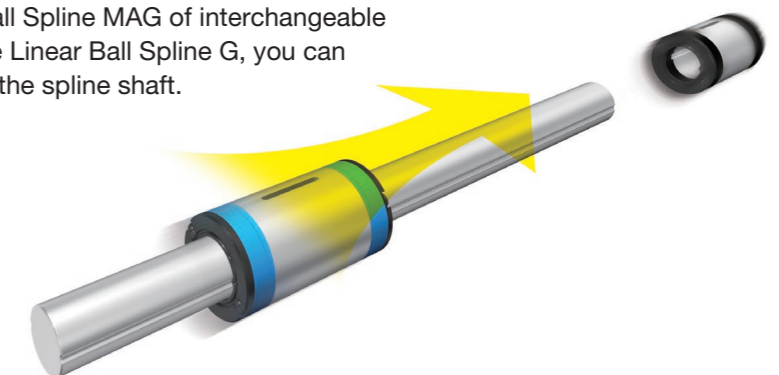

C-Lube Linear Ball Spline MAG

MAG



Long term maintenance free supported!

The aquamarine end plate is the symbol of maintenance free.



Points

1 Compact size

Uses a unique ball retaining mechanism without using a retainer, allowing a small external cylinder outside diameter against shaft diameter.

2 Extremely small size realized by simple structure

The minimum size LSAG2 realizes an unparalleled small size of 2 mm shaft diameter and 6 mm external cylinder's outside diameter.

3 Wide range of variations for your needs

The external cylinder shape can be selected from two types, the standard (cylindrical shape) type and the flange type, and there are two types with different length of external cylinder with same section.

Also for spline shaft, the solid shaft and the hollow shaft that allows piping/wiring/air removal are prepared for your selection to meet the requirements of mechanical/unit specifications.

4 Stainless steel shaft with high corrosion resistance

The spline shafts made of stainless steel are highly corrosion-resistant. They are suitable where rust prevention oil is not preferred, such as in a cleanroom environment.

Identification Number and Specification

Example of an identification number

The specifications of MAG and LSAG series are indicated by the identification number. Indicate the identification number, consisting of a model code, dimensions, a part code, a preload symbol, a classification symbol, an interchangeable code, and any supplemental codes for each specification to apply.

	1	2	3	4	5	6	7	8	9	10
Non-interchangeable specification										
Assembled set	MAG	L	T	5	C1	R150	T ₁	H		/N
Interchangeable specification										
Single external cylinder	MAG	L		5	C1		T ₁	H	S1	/N
Single spline shaft (1)	LSAG		T	5		R150		H	S1	
Assembled set	MAG	L	T	5	C1	R150	T ₁	H	S1	/N

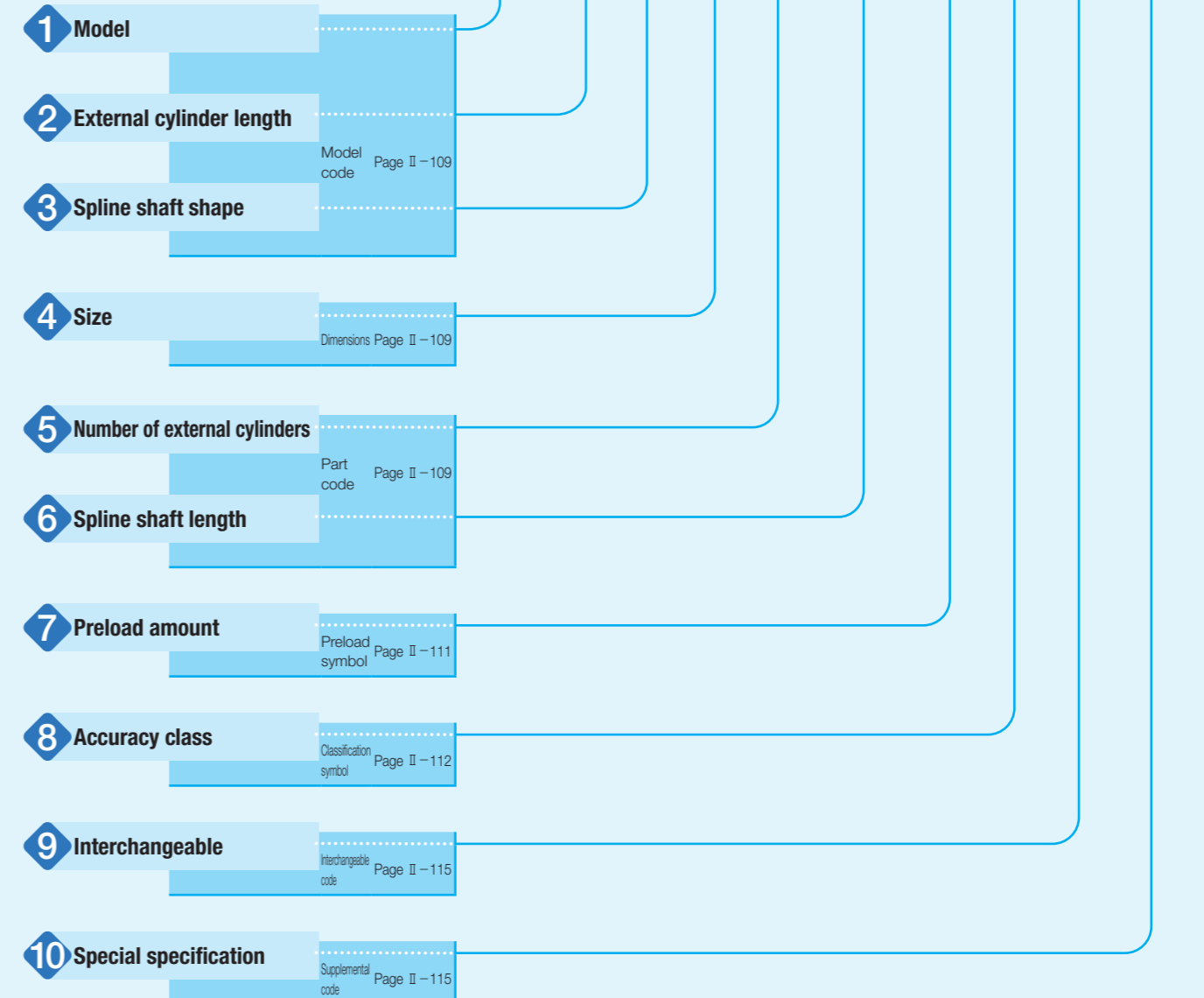







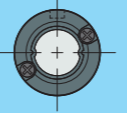
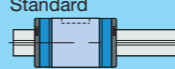

Note (1) Indicate "LSAG" (solid shaft) or "LSAGT" (hollow shaft) for the model code of the single spline shaft regardless of the series and the combination of external cylinder models.

Identification Number and Specification — Model · External Cylinder Length ·

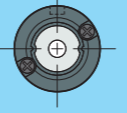
1 Model	C-Lube Linear Ball Spline MAG (MAG series)	Standard type : MAG Flange type : MAGF
	Linear Ball Spline G ⁽¹⁾ (LSAG series)	Standard type : LSAG Flange type : LSAGF
<p>For applicable models and sizes, see Table 1. Indicate "LSAG" (solid shaft) or "LSAGT" (hollow shaft) for the model code of the single spline shaft regardless of the series and the combination of external cylinder models.</p> <p>Note ⁽¹⁾ This model has no built-in C-Lube.</p>		
2 External cylinder length	Standard : No symbol Long : L	For applicable models and sizes, see Table 1.
3 Spline shaft shape	Solid shaft : No symbol Hollow shaft : T	For applicable models and sizes, see Table 1.
4 Size	2, 3, 4, 5, 6, 8, 10, 12, 15, 20, 25, 30	For applicable models and sizes, see Table 1.
5 Number of external cylinders	: C○	For an assembled set, indicates the number of external cylinders assembled on a spline shaft. For a single external cylinder, only "C1" is specified.
6 Spline shaft length	: R○	The spline shaft length is indicated in mm. For standard and maximum lengths, see the dimension table.

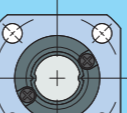
Spline Shaft Shape · Size · Number of External Cylinders · Spline Shaft Length —

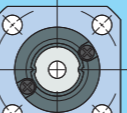
Table 1 Models and sizes of MAG and LSAG series

Shape	External cylinder length	Model	Size											
			2	3	4	5	6	8	10	12	15	20	25	30
Standard type Solid shaft 	Standard 	MAG	-	-	○	○	○	○	○	○	-	-	-	-
		LSAG	○	○	○	○	○	○	○	○	○	○	○	○
	Long 	MAGL	-	-	○	○	○	-	-	-	-	-	-	
		LSAGL	-	-	-	○	○	○	○	○	○	○	○	
Standard type Hollow shaft 	Standard 	MAGT	-	-	○	○	○	○	○	-	-	-		
		LSAGT	-	-	○	○	○	○	○	-	-	-		
	Long 	MAGLT	-	-	○	○	○	-	-	-	-	-		
		LSAGLT	-	-	-	○	○	○	○	-	-	-		
Flange type Solid shaft 	Standard 	MAGF	-	-	-	○	○	○	○	-	-	-		
		LSAGF	○	○	○	○	○	○	○	○	○	○		
	Long 	LSAGFL	-	-	-	○	○	○	○	○	○	○		
		MAGFT	-	-	-	○	○	○	○	-	-	-		
Flange type Hollow shaft 	Standard 	MAGFT	-	-	-	○	○	○	○	-	-	-		
		LSAGFT	-	-	○	○	○	○	○	-	-	-		
	Long 	LSAGFLT	-	-	-	○	○	○	○	-	-	-		

Remark: For the models indicated in , the interchangeable specification is available.

MAG · LSAG

—Preload Amount—

7	Preload amount	Clearance Standard	: T ₀	Specify this item for an assembled set or a single external cylinder. For details of the preload amount, see Table 2. For applicable preload types, see Table 3.
		Light preload	: No symbol	
			: T ₁	

Table 2 Preload amount

Preload type	Item	Preload symbol	Preload amount N	Operational conditions
Clearance		T ₀	0 ⁽¹⁾	· Very light motion
Standard		(No symbol)	0 ⁽²⁾	· Light and precise motion
Light preload		T ₁	0.02 C ₀	· Almost no vibrations · Load is evenly balanced · Light and precise motion

Notes ⁽¹⁾ There is zero or subtle clearance.

⁽²⁾ Indicates zero or minimal amount of preload.

Remark: C₀ indicates the basic static load rating.

Table 3 Application of preload

Size	Preload type (preload symbol)		
	Clearance (T ₀)	Standard (No symbol)	Light preload (T ₁)
2	○	○	—
3	○	○	—
4	○	○	—
5	—	○	○
6	—	○	○
8	—	○	○
10	—	○	○
12	—	○	○
15	—	○	○
20	—	○	○
25	—	○	○
30	—	○	○

Remark: The mark indicates that interchangeable specifications products are available.

—Accuracy Class—

8	Accuracy class	Ordinary	: No symbol	For interchangeable specification products, assemble an external cylinder and a spline shaft of the same accuracy class. For applicable accuracy class, see Table 4. For details of accuracy class, see Table 5, Table 6, and Table 7.
		High	: H	
		Precision	: P	

Table 4 Application of accuracy class

Size	Class (classification symbol)		
	Ordinary (No symbol)	High (H)	Precision (P)
2	○	○	○
3	○	○	○
4	○	○	○
5	○	○	○
6	○	○	○
8	○	○	○
10	○	○	○
12	○	○	○
15	○	○	○
20	○	○	○
25	○	○	○
30	○	○	○

Remark: The mark indicates that interchangeable specifications products are available.

Table 5 Tolerance of each part

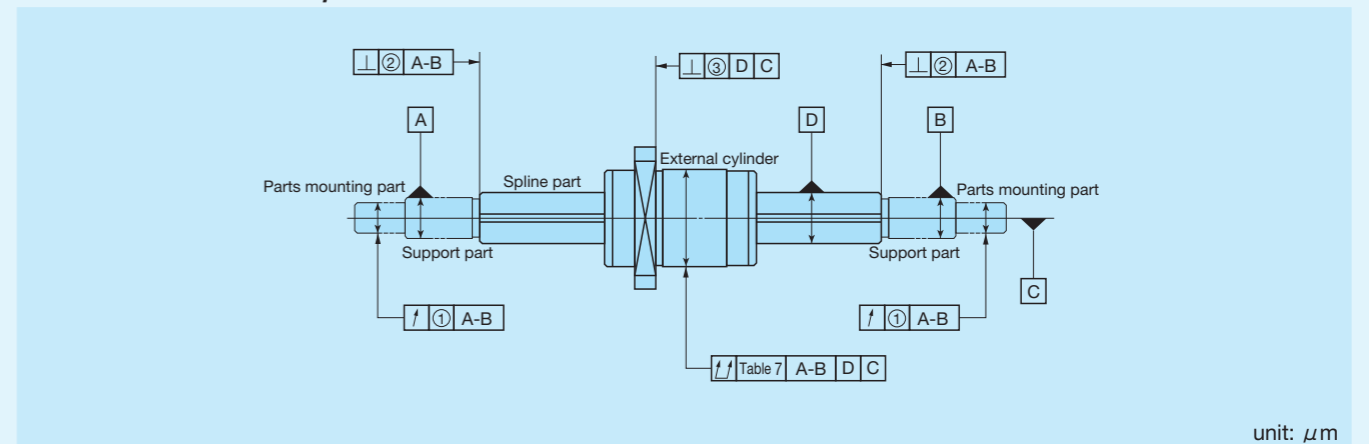

Size	Relative to axial line of supporting part of spline shaft						③ Perpendicularity of mounting surface of flange with respect to axial line of spline shaft ⁽²⁾		
	① Radial runout of periphery of parts mounting part ⁽¹⁾			② Perpendicularity of spline part end face ⁽¹⁾			Ordinary (No symbol)	High (H)	Precision (P)
	Ordinary (No symbol)	High (H)	Precision (P)	Ordinary (No symbol)	High (H)	Precision (P)			
2	33	14	8	22	9	6	27	11	8
3	33	14	8	22	9	6	27	11	8
4	33	14	8	22	9	6	27	11	8
5	33	14	8	22	9	6	27	11	8
6	33	14	8	22	9	6	27	11	8
8	33	14	8	22	9	6	27	11	8
10	41	17	10	22	9	6	33	13	9
12	41	17	10	22	9	6	33	13	9
15	46	19	12	27	11	8	33	13	9
20	46	19	12	27	11	8	33	13	9
25	53	22	13	33	13	9	39	16	11
30	53	22	13	33	13	9	39	16	11

Notes ⁽¹⁾ The values are for the processed shaft ends.

⁽²⁾ Applicable to the flange type.

Table 6 Twist of grooves with respect to effective length of the spline part
unit: μm

Accuracy class	Ordinary (No symbol)	High (H)	Precision (P)
Allowable value	33	13	6

Remark: The values can be applied to 100 mm of the effective length of the spline at any position.

Table 7 Allowable values of total radial runout of spline shaft axial line
unit: μm

Size and accuracy class		Size								
		2, 3, 4, 5, 6, 8			10, 12			15, 20		
Overall length of spline shaft mm		Ordinary (No symbol)	High (H)	Precision (P)	Ordinary (No symbol)	High (H)	Precision (P)	Ordinary (No symbol)	High (H)	Precision (P)
—	200	72	46	26	59	36	20	56	34	18
200	315	133	89	57	83	54	32	71	45	25
315	400	185	126	82	103	68	41	83	53	31
400	500	236	163	108	123	82	51	95	62	38
500	630	—	—	—	151	102	65	112	75	46
630	800	—	—	—	190	130	85	137	92	58
800	1 000	—	—	—	—	—	—	170	115	75
1 000	1 250	—	—	—	—	—	—	—	—	—

Size and accuracy class		Size		
		25, 30		
Overall length of spline shaft mm		Ordinary (No symbol)	High (H)	Precision (P)
—	200	53	32	18
200	315	58	39	21
315	400	70	44	25
400	500	78	50	29
500	630	88	57	34
630	800	103	68	42
800	1 000	124	83	52
1 000	1 250	151	102	65

Table 8 Measuring methods of accuracy

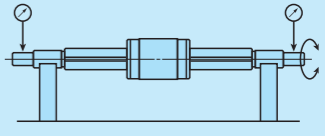
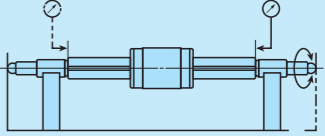
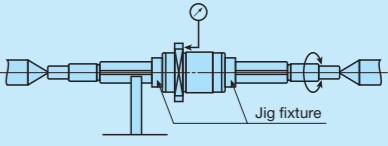
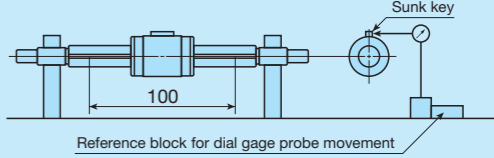
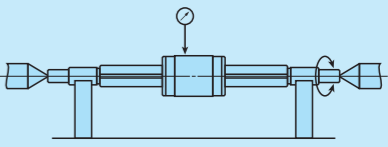
Item	Measuring method	Illustration of measuring method
(1) Radial runout of periphery of parts mounting part with respect to axial line of supporting part of spline shaft (see Table 5 ①)	While supporting the spline shaft at its support part, place the dial gage probes on the outer peripheral faces of the parts mounting part and measure the deflection from one rotation of the spline shaft.	
(1) Perpendicularity of spline part end face with respect to axial line of supporting part of spline shaft (See Table 5 ②)	While supporting the spline shaft at its support part and one spline shaft end, place the dial gage probes on the spline end faces and obtain perpendicularity by measuring the deflection from one rotation of the spline shaft.	
Perpendicularity of mounting surface of flange with respect to axial line of spline shaft (see Table 5 ③)	While supporting the spline shaft at both centers and the outer peripheral faces of the spline shaft near the external cylinder and fixing the external cylinder on the spline shaft, place the dial gage probe on the flange mounting surface and obtain perpendicularity by measuring the deflection from one rotation of the spline shaft.	
Twist of grooves with respect to effective length of the spline part (see Table 6)	While supporting the spline shaft fixed, apply a unidirectional torsion moment load to the external cylinder (or measuring unit), place the dial gage probe vertically to the spline shaft on the side face of the sunk key attached on the external cylinder, and measure the deflection when the external cylinder and the dial gage probe are moved 100 mm in the axial direction at any position on the effective length of the spline shaft. However, the dial gage probe should be applied as near as possible to the outer peripheral face of the external cylinder.	
Total radial runout of axial line of spline shaft (see Table 7)	While supporting the spline shaft at its support part or at both centers, place a dial gage probe on the outer peripheral face of the external cylinder (or measuring unit) and measure the deflection from one rotation of the spline shaft at several positions in the axial direction to obtain the maximum value.	

Note (1) The accuracy are for the processed shaft ends.

9 Interchangeable

S1 specification : S1 This is specified for the interchangeable specifications.
 S2 specification : S2 Assemble a spline shaft and an external cylinder with the same interchangeable code. When using in combination with different interchangeable codes, please contact IKO. Note that the combination of interchangeable codes will not have any effect on accuracy.
 Non-interchangeable specification : No symbol "No symbol" is indicated for non-interchangeable specification.
 For applicable models and sizes, see Table 1.
 "No symbol" is indicated for non-interchangeable specification.

10 Special specification

/BS, /N, /OH, /Q, /RE, /S, /Y
 For applicable special specifications, see Table 9.1 and Table 9.2.
 For combination of multiple special specifications, see Table 10.
 For details of special specifications, see pages II-116 and II-117.

Table 9.1 Application of special specifications (Interchangeable specification, single external cylinder, and assembled set)

Special specification	Supplemental code	Size											
		2	3	4	5	6	8	10	12	15	20	25	30
No seal	/N	–	–	–	○	○	○	○	○	○	○	○	○
Oil hole (1)	/OH	–	–	–	○	○	○	○	○	○	○	○	○
With C-Lube plate (1)	/Q	–	–	–	○	○	○	○	○	–	–	–	–

Note (1) Applicable to LSAG series.

Table 9.2 Application of special specifications (Non-interchangeable specification)

Special specification	Supplemental code	Size											
		2	3	4	5	6	8	10	12	15	20	25	30
Stainless steel end plate (1)	/BS	–	–	–	○	○	○	○	○	○	–	–	–
No seal	/N	–	–	–	○	○	○	○	○	○	○	○	○
Oil hole (1)	/OH	–	○	○	○	○	○	○	○	○	○	○	○
With C-Lube plate (1)	/Q	–	–	–	○	○	○	○	○	–	–	–	–
Special environment seal (1)	/RE	–	–	–	○	○	○	○	○	○	–	–	–
Stainless steel spline shaft (2)	/S	–	–	–	○	○	○	○	○	○	○	○	○
Specified grease (1)	/Y	–	–	–	○	○	○	○	○	○	–	–	–

Notes (1) Applicable to LSAG series.

(2) Applicable to solid shaft.

Table 10 Combination of supplemental codes

N	●												
OH	●	○											
Q	●	○	○										
RE	●	–	●	●									
S	●	●	●	●	●								
Y	●	●	●	●	●	●							
	BS	N	OH	Q	RE	S							

Remarks 1. The combination of "–" shown in the table is not available.

2. Contact IKO for the combination of the interchangeable specification marked with ●.

3. When using multiple types for combination, please indicate by arranging the symbols in alphabetical order.

Stainless steel end plate /BS

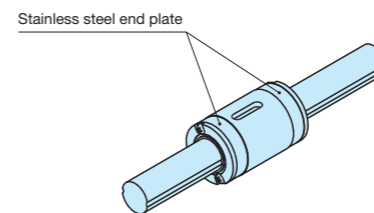

The standard synthetic resin end plates are replaced with stainless steel end plates. The total length of the external cylinder remains unchanged.

No seal /N

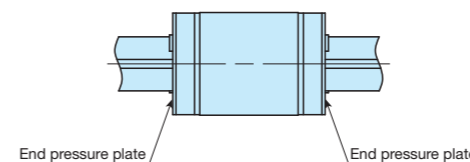

Seals at both ends of the external cylinder can be replaced with end pressure plates, which do not come in contact with the spline shaft, to reduce frictional resistance.
 This specification is not effective for dust protection.

Oil hole /OH

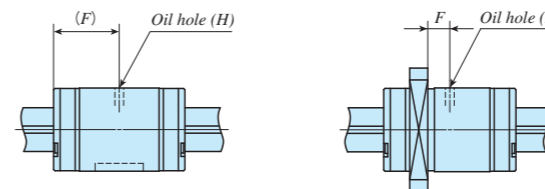

An oil hole is created on the external cylinder. For dimensions, see Table 11.1 and Table 11.2.

Table 11.1 Location and diameter of oil hole on a standard type external cylinder (Supplemental code /OH)

Identification number	F	H	unit: mm		
			Identification number	F	H
LSAG 3	5	1.2	–	–	–
LSAG 4	6	1.5	–	–	–
LSAG 5	9		LSAGL 5	13	1.5
LSAG 6	10.5		LSAGL 6	15	
LSAG 8	12.5	LSAGL 8	18.5	2	
LSAG10	15	LSAGL10	23.5		
LSAG12	17.5	LSAGL12	27		
LSAG15	20	LSAGL15	32.5	3	
LSAG20	25	LSAGL20	35.5		
LSAG25	30	LSAGL25	42		
LSAG30	35	LSAGL30	49		

Identification number	F	H	unit: mm		
			Identification number	F	H
LSAGF 3	2.1	1.2	–	–	–
LSAGF 4	2.8	1.5	–	–	–
LSAGF 5			LSAGFL 5	5.8	1.5
LSAGF 6	LSAGFL 6		8		
LSAGF 8	3.5	LSAGFL 8	9.5	2	
LSAGF10	5	LSAGFL10	13.3		
LSAGF12	7.5	LSAGFL12	17		
LSAGF15	9	LSAGFL15	21.5	3	
LSAGF20	11	LSAGFL20	21.5		
LSAGF25	13	LSAGFL25	25		
LSAGF30	14	LSAGFL30	28		

Remark: A typical identification number is indicated, but is applied to all LSAG series standard type models of the same size.

Table 11.2 Location and diameter of oil hole on a flange type external cylinder (Supplemental code /OH)

Identification number	F	H	unit: mm		
			Identification number	F	H
LSAGF 3	2.1	1.2	–	–	–
LSAGF 4	2.8	1.5	–	–	–
LSAGF 5			LSAGFL 5	5.8	1.5
LSAGF 6	LSAGFL 6		8		
LSAGF 8	3.5	LSAGFL 8	9.5	2	
LSAGF10	5	LSAGFL10	13.3		
LSAGF12	7.5	LSAGFL12	17		
LSAGF15	9	LSAGFL15	21.5	3	
LSAGF20	11	LSAGFL20	21.5		
LSAGF25	13	LSAGFL25	25		
LSAGF30	14	LSAGFL30	28		

Identification number	F	H	unit: mm		
			Identification number	F	H
LSAGF 3	2.1	1.2	–	–	–
LSAGF 4	2.8	1.5	–	–	–
LSAGF 5			LSAGFL 5	5.8	1.5
LSAGF 6	LSAGFL 6		8		
LSAGF 8	3.5	LSAGFL 8	9.5	2	
LSAGF10	5	LSAGFL10	13.3		
LSAGF12	7.5	LSAGFL12	17		
LSAGF15	9	LSAGFL15	21.5	3	
LSAGF20	11	LSAGFL20	21.5		
LSAGF25	13	LSAGFL25	25		
LSAGF30	14	LSAGFL30	28		

Remark: A typical identification number is indicated, but is applied to all LSAG series flange type models of the same size.

With C-Lube plate /Q

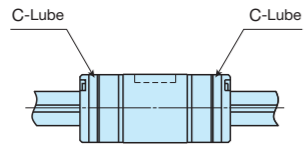

The C-Lube impregnated with lubrication oil is attached inside the seal of the external cylinder, so that the interval for reapplying lubricant can be extended. For the total length of the external cylinder with C-Lube plate, see Table 12.

Table 12 Dimension of external cylinder with C-Lube plate (Supplemental code /Q)

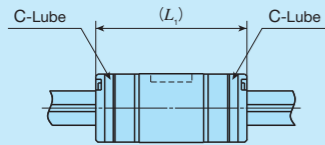

unit: mm

Identification number	L_1	Identification number	L_1
LSAG 5	24	LSAGL 5	32
LSAG 6	27	LSAGL 6	36
LSAG 8	33	LSAGL 8	45
LSAG10	38	LSAGL10	55
LSAG12	43	LSAGL12	62

Remarks 1. The dimensions of the external cylinder with C-Lube at both ends are indicated.
2. A typical identification number is indicated, but is applied to all LSAG series models of the same size.

Special environment seal /RE

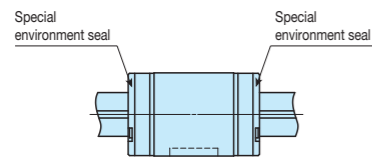

The standard seals are replaced with seals for special environment that can be used at high temperatures. The total length of the external cylinder remains unchanged.

Stainless steel spline shaft /S

The material of the solid spline shaft is changed to stainless steel. The load rating will change to a value obtained by multiplying the load rating for the steel spline shaft by a factor of 0.8.

Specified grease /YCG /YCL /YAF /YBR /YNG

The type of pre-packed grease can be changed by the supplemental code.

- ① /YCG Low Dust-Generation Grease for Clean Environment CG2 is pre-packed.
- ② /YCL Low Dust-Generation Grease for Clean Environment CGL is pre-packed.
- ③ /YAF Anti-Fretting Corrosion Grease AF2 is pre-packed.
- ④ /YBR MOLYCOTE BR2 Plus Grease [Dow Corning] is pre-packed.
- ⑤ /YNG No grease is pre-packed.

Spline shaft strength

IKO Linear Ball Spline spline shafts can receive loads in all directions. Therefore, attention must be paid to spline shaft strength.

For bending load

For bending load on the spline shaft, select a shaft diameter that fulfills the conditions in formula (1).

$$M = \sigma \times Z \dots\dots\dots (1)$$

M : Maximum bending moment acting on spline shaft N·mm
 σ : Spline shaft allowable bending stress 98 N/mm²
 Z : Section modulus of spline shaft mm³ (See Table 13)

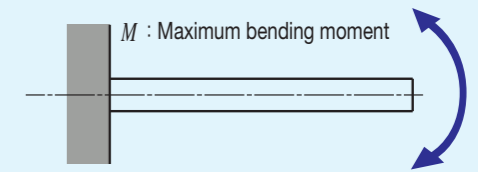

For torsion load

For torsion load on the spline shaft, select a shaft diameter that fulfills the conditions in formula (2).

$$T = \tau a \times Z_p \dots\dots\dots (2)$$

T : Maximum torsion moment N·mm
 τa : Spline shaft allowable torsion stress 49 N/mm²
 Z_p : Polar section modulus of spline shaft mm³ (See Table 13)

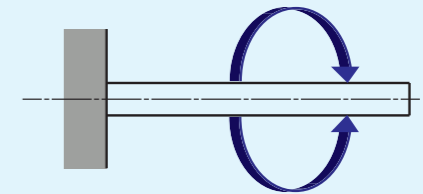

For simultaneous torsion and bending load

For simultaneous torsion and bending load on the spline shaft, calculate the shaft diameters from the equivalent bending moment formula (3) and the equivalent torsion moment formula (4) and use the larger value.

Equivalent bending moment Me

$$Me = \frac{1}{2}(M + \sqrt{M^2 + T^2}) \dots\dots\dots (3)$$

$$Me = \sigma \times Z$$

Equivalent torsion moment Te

$$Te = \sqrt{M^2 + T^2} \dots\dots\dots (4)$$

$$Te = \tau a \times Z_p$$

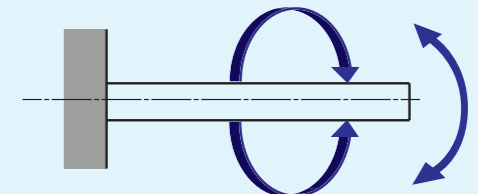

Stiffness of spline shaft

The torsion angle of the spline shaft caused by torsion moment must not exceed 0.25° per 1 meter.

$$\theta = \frac{T \times L}{G \times Ip} \times \frac{360}{2\pi} \dots\dots\dots (5)$$

$$0.25^\circ \geq \frac{1000}{L} \theta$$

θ : Torsion angle °
 L : Spline shaft length mm
 G : Shear Modulus 7.9 × 10⁴ N/mm²
 Ip : Polar moment of inertia of section area of spline shaft mm⁴ (See Table 13)

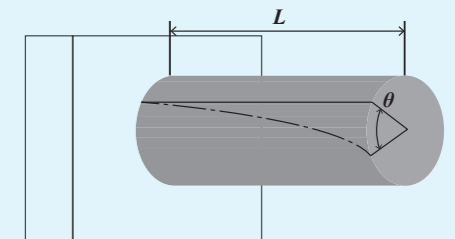

Spline shaft sectional characteristics

Table 13 Spline shaft sectional characteristics

Size	Moment of inertia of sectional area mm ⁴		Section modulus : Z mm ³		Polar moment of inertia of section area of spline shaft: I _p mm ⁴		Polar section modulus : Z _p mm ³	
	Solid shaft	Hollow shaft	Solid shaft	Hollow shaft	Solid shaft	Hollow shaft	Solid shaft	Hollow shaft
2	0.60	—	0.65	—	1.4	—	1.4	—
3	3.6	—	2.5	—	7.5	—	5.0	—
4	12	12	6.0	6.0	24	24	12	12
5	29	28	12	11	59	58	24	23
6	61	60	21	20	120	120	41	41
8	190	190	49	47	390	380	98	96
10	470	460	95	93	960	940	190	190
12	990	920	170	160	2 010	1 880	330	310
15	1 580	—	240	—	3 260	—	480	—
20	5 100	—	570	—	10 500	—	1 150	—
25	12 000	—	1 080	—	24 800	—	2 200	—
30	25 300	—	1 890	—	52 200	—	3 840	—

Load Direction and Load Rating

The MAG and LSAG series must be used with their load rating corrected in accordance to the load direction. The basic dynamic load rating and basic static load rating shown in the dimension table should be corrected to values in Table 14.

Table 14 Load ratings corrected for load direction

Size	Load rating and load direction			Basic dynamic load rating			Basic static load rating		
	Load direction			Load direction			Load direction		
	Downward	Upward	Lateral	Downward	Upward	Lateral	Downward	Upward	Lateral
2~12	C	C	1.47C	C ₀	C ₀	1.73C ₀	0.16~0.25	1	1.25
15~30	C	C	1.13C	C ₀	C ₀	1.19C ₀			

Identification number and quantity for ordering

To order an assembled set of MAG and LSAG series, please specify the number of sets based on the number of spline shafts. For single external cylinder or single spline shaft of the interchangeable specification, please specify the number of units.

Non-interchangeable specification

Assembled set

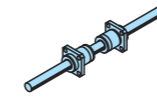

(When 1 set is needed)

Example of identification number indication
MAGF 10 C2 R200 T1 H /N

Order quantity
1 set

Interchangeable specification

Single external cylinder



(When 2 pieces are needed)

Example of identification number indication
MAGF 10 C1 T1 H S○ /N

Order quantity
2 pieces

Please specify S1 or S2.
Only C1 can be specified.

Single spline shaft

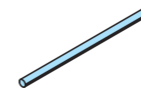

(When 1 unit is needed)

Example of identification number indication
LSAG 10 R200 H S○

Order quantity
1 unit

Please specify S1 or S2.

Assembled set

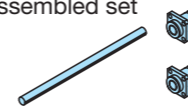

(When 1 set is needed)

Example of identification number indication
MAGF 10 C2 R200 T1 H S○ /N

Order quantity
1 set

Please specify S1 or S2.

Dimensions of Attached Key

The MAG and LSAG series standard types have keys shown in Table 15 attached.

Table 15 Dimensions and tolerance of attached key

Size	b	Dim. b tolerance	h	Dim. h tolerance	ℓ	r	C
5	2	+0.016 +0.006	2	0 -0.025	3.8	1	0.16~0.25
6			2.5		5.8		
8	3	+0.024 +0.012	3	0 -0.030	7.8	1.5	
10			3.5		11.8		
15	4	+0.030 +0.015	4	0 -0.036	16	1.75	
20	5		21.5		2		
25	7	23.5	2.5	0.25~0.4	27.5	3.5	
30	7	27.5	3.5				

unit: mm

Remark: No key is attached to the Size 2, 3, and 4 series. For details of how to fix the key, see page II -121.

Lubrication

Lithium-soap base grease with extreme-pressure additive (Alvania EP Grease 2 [Shell Lubricants Japan K.K.]) is pre-packed in MAG and LSAG series. Additionally, MAG series has C-Lube placed in the recirculation part of balls, so that the interval for reapplying lubricant can be extended and maintenance works such as grease job can be reduced significantly.

Perform re-greasing as below.

(1) Size 2, 3, and 4 series

Specify either direct application of grease to the spline shaft raceway surface or oil hole specification (/OH). Note that the oil hole specification (/OH) is not available for the Size 2 series.

(2) Size 5 and higher series

Apply grease directly to the spline shaft raceway surface or the rolling elements. You may also specify the oil hole specification (/OH).

Dust Protection

The external cylinders of MAG and LSAG series are equipped with special rubber seals as standard for dust protection. However, if large amount of contaminant or dust are floating, or if large particles of foreign substances such as chips or sand may adhere to the spline shaft, it is recommended to attach a protective cover to the linear motion mechanism. The Size 2, 3, and 4 series are not provided with seals. If the Size 3 and 4 series with seals is needed, contact IKO.

Precaution for Use

① Fitting of external cylinder

Generally, transition fit (J7) is used for fitting between the external cylinder and the housing bore. When high accuracy and high rigidity are not required, clearance fit (H7) can also be used.

② Typical mounting structure

Mounting examples of the external cylinder are shown in Fig. 1.

The rotation detent for external cylinders of the Size 2, 3, and 4 series should be mounted using the countersink provided on the external cylinder. Use screws M1.2 to M1.6 for Size 2, M1.6 to M2 for Size 3, and M2 to M2.5 for Size 4. At this point, be careful not to deform the external cylinder with screws.

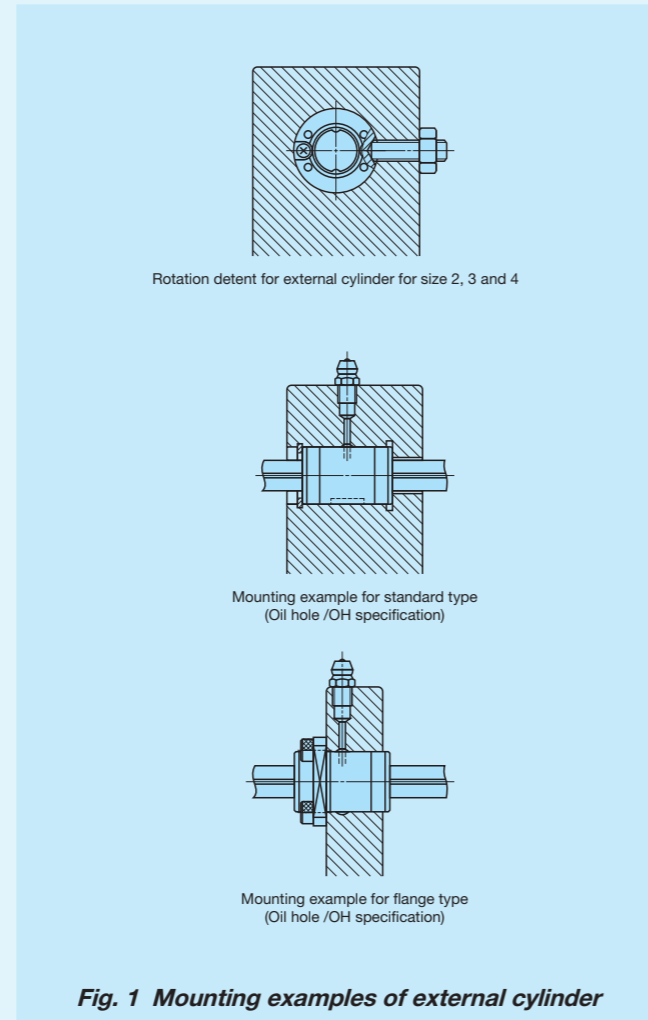

③ Multiple external cylinders used in close proximity

When using multiple external cylinders in close proximity, greater load may be applied than the calculated value depending on the accuracy of the mounting surfaces and reference mounting surfaces of the machine or device. In such cases, allowance for greater applied load than the calculated value should be made.

If two or more external cylinders are assembled on a spline shaft and two or more keys are used to fix the rotational direction of the external cylinder, the keyway position of the external cylinders are aligned before delivery. Please contact IKO.

④ Additional machining of spline shaft end

- When machining the outside surface of the spline shaft, make sure that the maximum diameter of the end machining part does not exceed d_1 in the dimension table. If the machined outside surface exceeds d_1 , it will leave a track groove.
- Perform annealing if additional machining will be performed.
- Shaft guide shapes for spline shafts can be prepared upon request. Please contact IKO for further information.

⑤ Operating temperature

MAG Series contains C-Lube. The operating temperature should not exceed 80°C. The maximum operating temperature for LSAG series is 120°C and temperature up to 100°C is allowed for continuous operation. When the temperature exceeds 100°C, contact IKO.

When specifying LSAG series special specification with C-Lube plate (supplemental code /Q), utilize it below 80°C.

⑥ Arrangement of flange type (non-interchangeable specification) external cylinder

Table 16 shows arrangements of multiple flange type external cylinders in non-interchangeable specification. Arrangements that are not in Table 16 can be prepared upon request. Contact IKO for further information.

Table 16 Arrangement of flange type (Non-interchangeable specification) external cylinder

Number of external cylinders	Arrangement of external cylinders
1	
2	
3	
4	
5	
6	

⑦ When mounting multiple assembled sets at the same time

For interchangeable specification products, assemble an external cylinder and a spline shaft with the same interchangeable code ("S1" or "S2").

For non-interchangeable specification products, use the same combination of external cylinder and spline shaft upon delivery.

⑧ Assembly of external cylinder on spline shaft

When assembling the external cylinder on the spline shaft, correctly fit the grooves of the external cylinder and the spline shaft and move the external cylinder softly in parallel direction. Rough handling may result in damaging of seals or dropping of steel balls.

The non-interchangeable specification products are already adjusted so as to provide the best accuracy when the IKO marks of the external cylinder and the spline shaft face the same direction (see Fig. 2). Be careful not to change the assembly direction.

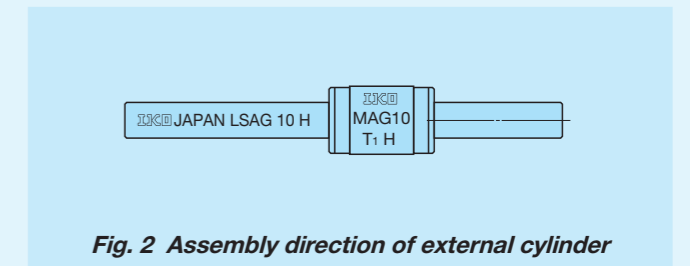

⑨ Mounting of external cylinder

When press-fitting the external cylinder to the housing, assemble them correctly by using a press and a suitable jig fixture. (See Fig. 3.)

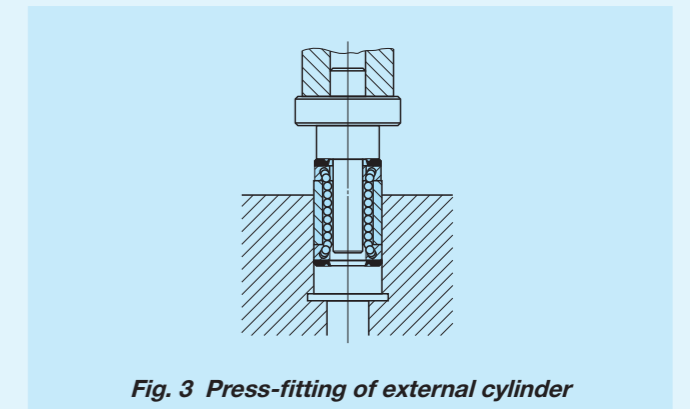

IKO C-Lube Linear Ball Spline MAG

Standard type													
Shape	MAG · LSAG												
Size	<table border="1"> <tr> <td>2</td><td>3</td><td>4</td><td>5</td><td>6</td><td>8</td> </tr> <tr> <td>10</td><td>12</td><td>15</td><td>20</td><td>25</td><td>30</td> </tr> </table>	2	3	4	5	6	8	10	12	15	20	25	30
2	3	4	5	6	8								
10	12	15	20	25	30								

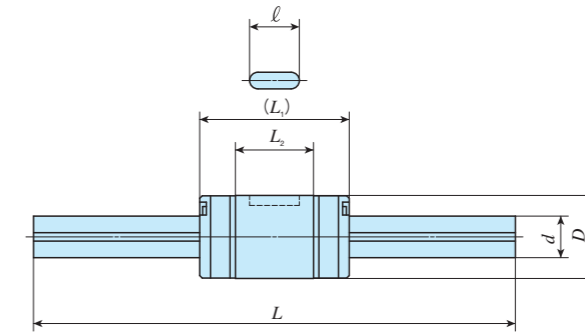
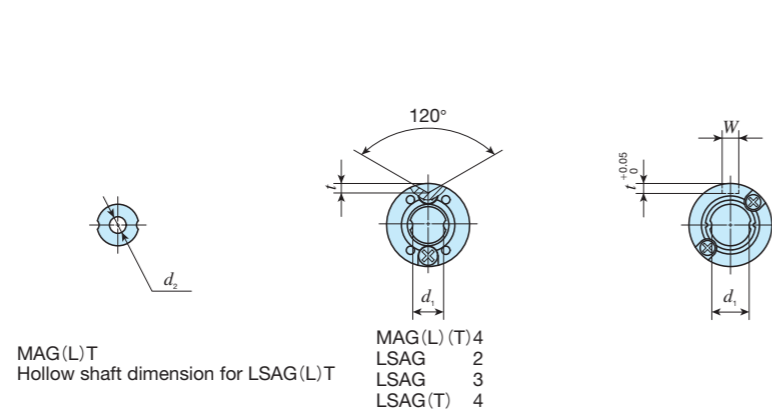

Identification number	Interchangeable	Mass (Ref.) g	External cylinder dimensions and tolerances mm										Spline shaft dimensions and tolerances mm					Basic dynamic load rating ⁽⁴⁾ C N	Basic static load rating ⁽⁴⁾ C ₀ N	Dynamic torque rating ⁽⁴⁾ T N · m	Static torque rating ⁽⁴⁾ T ₀ N · m	Static moment rating ⁽⁴⁾			
			External cylinder	Spline shaft (per 100 mm)	D	Dim. D tolerance	L ₁	L ₂	W	Dim. W tolerance	t	ℓ	d	Dim. d tolerance	d ₁ ⁽²⁾	d ₂	L ⁽³⁾					Maximum length	T _x N · m	T _y N · m	
—	LSAG 2 ⁽¹⁾	—	1.0	2.3	6	0 -0.008	8.5	4.7	—	—	0.7	—	2	—	0 -0.010	1.2	—	50 100	100	222	237	0.28	0.30	0.22 1.4	0.39 2.4
—	LSAG 3 ⁽¹⁾	—	2.1	5.4	7	0 -0.009	10	5.9	—	—	0.8	—	3	—	0 -0.010	2.2	—	100 150	150	251	285	0.45	0.51	0.31 3.3	0.53 3.3
MAG 4 ⁽¹⁾	LSAG 4 ⁽¹⁾	—	2.5	9.6	8	0 -0.009	15	7.9	—	—	1	—	4	—	0 -0.012	3.2	1.5	100 150	200	303	380	0.70	0.87	0.52 3.80	0.90 6.50
MAGT 4 ⁽¹⁾	LSAGT 4 ⁽¹⁾	—					15												12					0.52 2.9	0.90 5.0
MAGL 4 ⁽¹⁾	—	—	4.1	8.2	8	0 -0.009	21	13.9	—	—	1	—	4	—	0 -0.012	3.2	1.5	100 150	200	441	665	1.00	1.50	1.50 8.60	2.60 15.0
MAGLT 4 ⁽¹⁾	—	—					21												13.9					0.52 2.9	0.90 5.0
MAG 5	LSAG 5	○	4.8	14.9	10	0 -0.009	18	9.4	2	+0.014 0	1.2	6	5	—	0 -0.012	4.2	2	100 150	200	587	641	1.8	1.9	1.0 7.9	1.8 13.6
MAGT 5	LSAGT 5	○		14.9			26	16.9											0.52 2.9					0.90 5.0	
MAGL 5	LSAGL 5	○	8.1	14.9	10	0 -0.009	26	16.9	2	+0.014 0	1.2	6	5	—	0 -0.012	4.2	2	100 150	200	879	1 180	2.6	3.5	3.2 19.3	5.5 33.4
MAGLT 5	LSAGLT 5	○		14.9			26	16.9											0.52 2.9					0.90 5.0	
MAG 6	LSAG 6	○	8.9	19	12	0 -0.011	21	12.4	2	+0.014 0	1.2	8	6	—	0 -0.012	5.2	2	150 200	300	711	855	2.5	3.0	1.7 11.7	3.0 20.3
MAGT 6	LSAGT 6	○		16.5			30	21.4											0.52 2.9					0.90 5.0	
MAGL 6	LSAGL 6	○	14.5	19	12	0 -0.011	30	21.4	2	+0.014 0	1.2	8	6	—	0 -0.012	5.2	2	150 200	300	1 030	1 500	3.6	5.2	5.0 27.6	8.6 47.8
MAGLT 6	LSAGLT 6	○		16.5			30	21.4											0.52 2.9					0.90 5.0	
MAG 8	LSAG 8	○	15.9	39	15	0 -0.011	25	14.6	2.5	+0.014 0	1.5	8.5	8	—	0 -0.015	7	3	150 200 250	500	1 190	1 330	5.5	6.2	3.3 22.0	5.6 38.1
MAGT 8	LSAGT 8	○		33			37	26.6											0.52 2.9					0.90 5.0	
MAGL 8	LSAGL 8	○	26.5	39	15	0 -0.011	37	26.6	2.5	+0.014 0	1.5	8.5	8	—	0 -0.015	7	3	150 200 250	500	1 800	2 470	8.4	11.5	10.3 56.3	17.8 97.5
MAGLT 8	LSAGLT 8	○		33			37	26.6											0.52 2.9					0.90 5.0	

- Notes (1) No seal is included.
 (2) d_1 represents the maximum diameter for end machining. (Perform annealing if end machining will be performed.)
 (3) Represents standard length. We can produce other than the standard length, please specify the length of spline shaft by indicating the length in mm with the identification number.
 (4) The direction of basic dynamic load rating (C), basic static load rating (C₀), dynamic torque rating (T), static torque rating and static moment rating (T₀, T_x, T_y) are shown in the sketches below.
 The upper values of T_x and T_y are for one external cylinder and the lower values are for two external cylinders inclose contact.

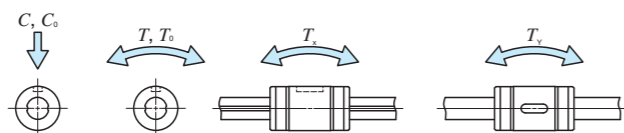

Example of identification number of assembled set

Model code Dimensions Part code Preload symbol Classification symbol Interchangeable code Supplemental code

MAG **L** **T** **5** **C2** **R150** **T1** **H** — **/N**

① ② ③ ④ ⑤ ⑥ ⑦ ⑧ ⑨ ⑩

① Model MAG Standard type LSAG Standard type	④ Size 2, 3, 4, 5, 6, 8	⑦ Preload amount To Clearance No symbol Standard T1 Light preload	⑩ Interchangeable No symbol Non-interchangeable specification S1 S1 specification S2 S2 specification
② Length of external cylinder No symbol Standard L Long	⑤ Number of external cylinders (2)	⑧ Accuracy class No symbol Ordinary H High P Precision	⑨ Special specification BS, N, OH, Q, RE, S, Y
③ Spline shaft shape No symbol Solid shaft T Hollow shaft	⑥ Length of spline shaft (150 mm)		

IKO C-Lube Linear Ball Spline MAG

Standard type	
Shape	MAG · LSAG
Size	2 3 4 5 6 8 10 12 15 20 25 30



MAGT
Hollow shaft dimension for LSAG(L)T

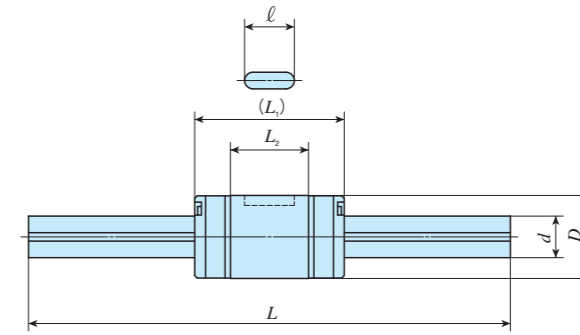

Identification number	Interchangeable	Mass (Ref.) g	External cylinder dimensions and tolerances mm										Spline shaft dimensions and tolerances mm					Basic dynamic load rating ⁽³⁾ C N	Basic static load rating ⁽³⁾ C ₀ N	Dynamic torque rating ⁽³⁾ T N · m	Static torque rating ⁽³⁾ T ₀ N · m	Static moment rating ⁽³⁾	
			External cylinder	Spline shaft (per 100 mm)	D	Dim. D tolerance	L ₁	L ₂	W	Dim. W tolerance	t	ℓ	d	Dim. d tolerance	d ₁ ⁽¹⁾	d ₂	L ⁽²⁾					Maximum length	T _x N · m
MAG 10	LSAG 10	31.5	60.5	19	0 -0.013	30	18.2	3	+0.014 0	1.8	11	10	0 -0.015	8.9	4	200 300	600	1 880	2 150	10.9	12.5	7.0 41.5	12.1 71.9
MAGT 10	LSAGT 10	51	51			47	34.9																
-	LSAGL 10	56.5	60.5	21	0 -0.013	35	23	3	+0.014 0	1.8	15	12	0 -0.018	10.9	6	200 300 400	800	2 180	2 690	14.8	18.3	10.6 59.1	18.3 102
-	LSAGLT 10	51	51			54	42																
MAG 12	LSAG 12	44	87.5	23	0 -0.013	40	27	3.5	+0.018 0	2	20	13.6	0 -0.018	11.6	-	200 300 400	1 000	4 180	6 070	31.3	45.6	27.8 152	33.2 181
MAGT 12	LSAGT 12	66	66			65	52																
-	LSAGL 12	76.8	87.5	30	0 -0.016	50	33	4	+0.018 0	2.5	26	18.2	0 -0.021	15.7	-	300 400 500	1 000	6 600	9 040	66.0	90.4	48.6 288	58.0 343
-	LSAGLT 12	66	66			71	54																
-	LSAG 15	59.5	111	37	0 -0.016	60	39.2	5	+0.018 0	3	29	22.6	0 -0.021	19.4	-	300 400 500	1 200	11 200	14 300	139	178	92.8 551	111 656
-	LSAGL 15	110	110			84	63.2																
-	LSAG 20	130	202	45	0 -0.016	70	43	7	+0.022 0	4	35	27.2	0 -0.021	23.5	-	400 500 600	1 200	15 400	19 400	231	292	147 874	176 1 040
-	LSAGL 20	198	202			98	71																
-	LSAG 25	220	310	45	0 -0.016	70	43	7	+0.022 0	4	35	27.2	0 -0.021	23.5	-	400 500 600	1 200	15 400	19 400	231	292	147 874	176 1 040
-	LSAGL 25	336	310			98	71																
-	LSAG 30	430	450	45	0 -0.016	70	43	7	+0.022 0	4	35	27.2	0 -0.021	23.5	-	400 500 600	1 200	15 400	19 400	231	292	147 874	176 1 040
-	LSAGL 30	634	450			98	71																

Notes (1) d_1 represents the maximum diameter for end machining. (Perform annealing if end machining will be performed.)
 (2) Represents standard length. We can produce other than the standard length, please specify the length of spline shaft by indicating the length in mm with the identification number.
 (3) The direction of basic dynamic load rating (C), basic static load rating (C₀), dynamic torque rating (T), static torque rating and static moment rating (T₀, T_x, T_y) are shown in the sketches below.
 The upper values of T_x and T_y are for one external cylinder and the lower values are for two external cylinders inclose contact.

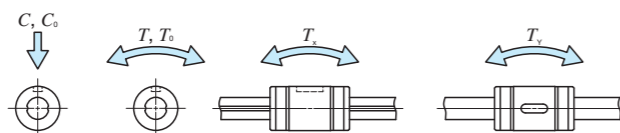

Example of identification number of assembled set

Model code: **MAG** Dimensions: **12** Part code: **C2** Preload symbol: **R300** Classification symbol: **T1** Interchangeable code: **H** Supplemental code: **/N**

① Model MAG Standard type LSAG	④ Size 10, 12, 15, 20, 25, 30	⑦ Preload amount No symbol Standard T1 Light preload	⑨ Interchangeable No symbol Non-interchangeable specification S1 S1 specification S2 S2 specification
② Length of external cylinder No symbol Standard L Long	⑤ Number of external cylinders (2)	⑧ Accuracy class No symbol Ordinary H High P Precision	⑩ Special specification BS, N, OH, Q, RE, S, Y
③ Spline shaft shape No symbol Solid shaft T Hollow shaft	⑥ Length of spline shaft (300 mm)		

IKO C-Lube Linear Ball Spline MAG

Flange type													
MAGF · LSAGF													
Shape													
Size	<table border="1"> <tr> <td>2</td><td>3</td><td>4</td><td>5</td><td>6</td><td>8</td> </tr> <tr> <td>10</td><td>12</td><td>15</td><td>20</td><td>25</td><td>30</td> </tr> </table>	2	3	4	5	6	8	10	12	15	20	25	30
2	3	4	5	6	8								
10	12	15	20	25	30								

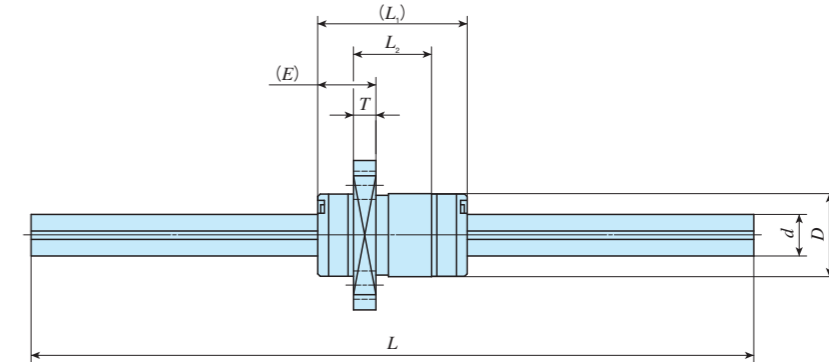
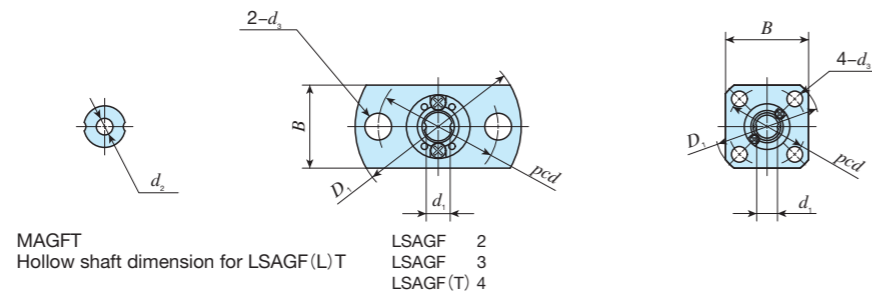

Identification number	Interchangeable	Mass (Ref.) g	External cylinder dimensions and tolerances mm												Spline shaft dimensions and tolerances mm						Basic dynamic load rating ⁽⁴⁾ C N	Basic static load rating ⁽⁴⁾ C ₀ N	Dynamic torque rating ⁽⁴⁾ T N·m	Static torque rating ⁽⁴⁾ T ₀ N·m	Static moment rating ⁽⁴⁾	
			External cylinder	Spline shaft (per 100 mm)	D	Dim. D tolerance	L ₁	L ₂	D ₁	B	E	T	pcd	d ₃	d	Dim. d tolerance	d ₁ ⁽²⁾	d ₂	L ⁽³⁾	Maximum length					T _x N·m	T _y N·m
—	LSAGF 2 ⁽¹⁾	—	1.9	2.3	6	0 -0.008	8.5	4.7	15.5	8	3.4	1.5	11	2.4	—	—	50	100	100	222	237	0.28	0.30	0.22	0.39	
—	LSAGF 3 ⁽¹⁾	—	3.7	5.4	7	0 -0.009	10	5.9	18	9	4	1.9	13	2.9	—	—	100	150	150	251	285	0.45	0.51	0.31	0.53	
—	LSAGF 4 ⁽¹⁾	—	5.1	9.6	8	0 -0.009	12	7.9	21	10	4.6	2.5	15	3.4	—	—	100	150	200	303	380	0.70	0.87	0.52	0.90	
—	LSAGFT 4 ⁽¹⁾	8.2		1.5															150							
MAGF 5	LSAGF 5	○	8.9	14.9	10	0 -0.009	18	9.4	23	18	7	2.7	17	3.4	—	—	100	150	200	587	641	1.8	1.9	1.0	1.8	
MAGFT 5	LSAGFT 5	○		12.4															2							
—	LSAGFL 5	○	12	14.9	10	0 -0.009	26	16.9	—	—	—	—	—	—	—	—	—	—	200	879	1 180	2.6	3.5	3.2	5.5	
—	LSAGFLT 5	○		12.4															2							
MAGF 6	LSAGF 6	○	13.9	19	12	0 -0.011	21	12.4	25	20	7	2.7	19	3.4	—	—	150	200	300	711	855	2.5	3.0	1.7	3.0	
MAGFT 6	LSAGFT 6	○		16.5															2							
—	LSAGFL 6	○	19.5	19	12	0 -0.011	30	21.4	—	—	—	—	—	—	—	—	—	—	300	1 030	1 500	3.6	5.2	5.0	8.6	
—	LSAGFLT 6	○		16.5															2							
MAGF 8	LSAGF 8	○	23.5	39	15	0 -0.011	25	14.6	28	22	9	3.8	22	3.4	—	—	150	200	250	1 190	1 330	5.5	6.2	3.3	5.6	
MAGFT 8	LSAGFT 8	○		33															3							
—	LSAGFL 8	○	34.1	39	15	0 -0.011	37	26.6	—	—	—	—	—	—	—	—	—	—	400	1 800	2 470	8.4	11.5	10.3	17.8	
—	LSAGFLT 8	○		33															3							

Notes (1) No seal is included.
 (2) d_1 represents the maximum diameter for end machining. (Perform annealing if end machining will be performed.)
 (3) Represents standard length. We can produce other than the standard length, please specify the length of spline shaft by indicating the length in mm with the identification number.
 (4) The direction of basic dynamic load rating (C), basic static load rating (C₀), dynamic torque rating (T), static torque rating and static moment rating (T₀, T_x, T_y) are shown in the sketches below.
 The upper values of T_x and T_y are for one external cylinder and the lower values are for two external cylinders inclose contact.

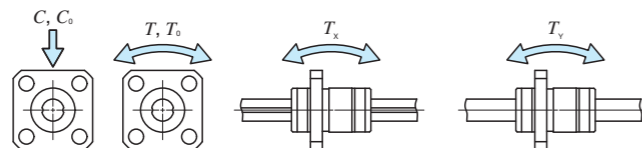

Example of identification number of assembled set

Model code Dimensions Part code Preload symbol Classification symbol Interchangeable code Supplemental code

MAGF **L** **T** **5** **C2** **R150** **T1** **H** — **/N**

① ② ③ ④ ⑤ ⑥ ⑦ ⑧ ⑨ ⑩

① Model MAGF Flange type LSAGF	④ Size 2, 3, 4, 5, 6, 8	⑦ Preload amount To Clearance No symbol Standard T1 Light preload	⑩ Interchangeable No symbol Non-interchangeable specification S1 S1 specification S2 S2 specification
② Length of external cylinder No symbol Standard L Long	⑤ Number of external cylinders (2)	⑧ Accuracy class No symbol Ordinary H High P Precision	⑨ Special specification BS, N, OH, Q, RE, S, Y
③ Spline shaft shape No symbol Solid shaft T Hollow shaft	⑥ Length of spline shaft (150 mm)		

MAG · LSAG

IKO C-Lube Linear Ball Spline MAG

Flange type													
Shape	MAGF · LSAGF												
Size	<table border="1"> <tr> <td>2</td><td>3</td><td>4</td><td>5</td><td>6</td><td>8</td> </tr> <tr> <td>10</td><td>12</td><td>15</td><td>20</td><td>25</td><td>30</td> </tr> </table>	2	3	4	5	6	8	10	12	15	20	25	30
2	3	4	5	6	8								
10	12	15	20	25	30								

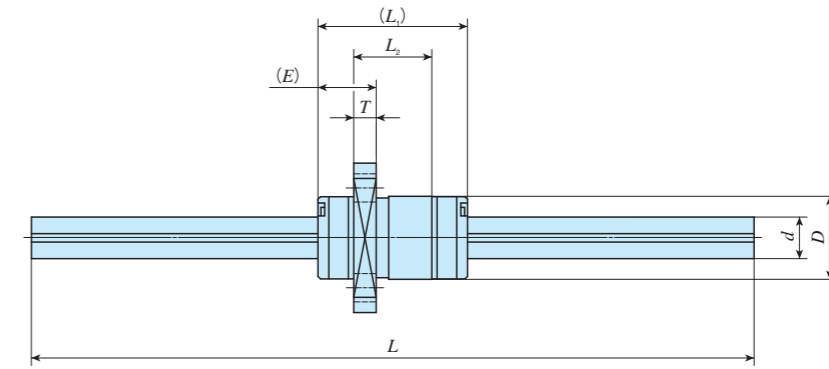
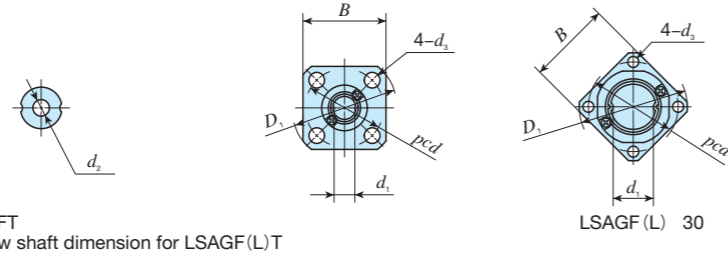

Identification number		Interchangeable	Mass (Ref.) g		External cylinder dimensions and tolerances mm									Spline shaft dimensions and tolerances mm					Basic dynamic load rating ⁽³⁾ C N	Basic static load rating ⁽³⁾ C ₀ N	Dynamic torque rating ⁽³⁾ T N · m	Static torque rating ⁽³⁾ T ₀ N · m	Static moment rating ⁽³⁾			
MAG series	LSAG series (No C-Lube)		External cylinder	Spline shaft (per 100 mm)	D	Dim. D tolerance	L ₁	L ₂	D ₁	B	E	T	pcd	d ₃	d	Dim. d tolerance	d ₁ ⁽¹⁾	d ₂					L ⁽²⁾	Maximum length	T _x N · m	T _y N · m
MAGF 10	LSAGF 10	○	45	60.5	19	0 -0.013	30	18.2	36	28	10	4.1	28	4.5	10	0 -0.015	8.9	4	200 300	600	1 880	2 150	10.9	12.5	7.0 41.5	12.1 71.9
MAGFT 10	LSAGFT 10	○		51			47	34.9																		
-	LSAGFL 10	○	70.1	60.5	21	0 -0.013	35	23	38	30	10	4	30	4.5	12	0 -0.018	10.9	6	200 300 400	800	2 180	2 690	14.8	18.3	10.6 59.1	18.3 102
-	LSAGFLT 10	○		51			54	42																		
MAGF 12	LSAGF 12	○	59	87.5	23	0 -0.013	40	27	40	31	11	4.5	32	4.5	13.6	0 -0.018	11.6	-	200 300 400	1 000	4 180	6 070	31.3	45.6	27.8 152	33.2 181
MAGFT 12	LSAGFT 12	○		66			65	52																		
-	LSAGFL 12	○	91.8	87.5	30	0 -0.016	50	33	46	35	14	5.5	38	4.5	18.2	0 -0.021	15.7	-	300 400 500	1 000	6 600	9 040	66.0	90.4	48.6 288	58.0 343
-	LSAGFLT 12	○		66			71	54																		
-	LSAGF 15	○	77	111	23	0 -0.013	60	39.2	57	43	17	6.6	47	5.5	22.6	0 -0.021	19.4	-	300 400 500	1 200	11 200	14 300	139	178	92.8 551	111 656
-	LSAGFL 15	○					128	84																		
-	LSAGF 20	○	150	202	30	0 -0.016	70	43	65	50	21	7.5	54	6.6	27.2	0 -0.021	23.5	-	400 500 600	1 200	15 400	19 400	231	292	147 874	176 1 040
-	LSAGFL 20	○					218	98																		
-	LSAGF 25	○	255	310	37	0 -0.016	84	63.2	57	43	17	6.6	47	5.5	22.6	0 -0.021	19.4	-	300 400 500	1 200	11 200	14 300	139	178	92.8 551	111 656
-	LSAGFL 25	○					371	84																		
-	LSAGF 30	○	476	450	45	0 -0.016	98	71	65	50	21	7.5	54	6.6	27.2	0 -0.021	23.5	-	400 500 600	1 200	15 400	19 400	231	292	147 874	176 1 040
-	LSAGFL 30	○					680	98																		

Notes (1) d_1 represents the maximum diameter for end machining. (Perform annealing if end machining will be performed.)
 (2) Represents standard length. We can produce other than the standard length, please specify the length of spline shaft by indicating the length in mm with the identification number.
 (3) The direction of basic dynamic load rating (C), basic static load rating (C₀), dynamic torque rating (T), static torque rating and static moment rating (T_x, T_y) are shown in the sketches below.
 The upper values of T_x and T_y are for one external cylinder and the lower values are for two external cylinders inclose contact.

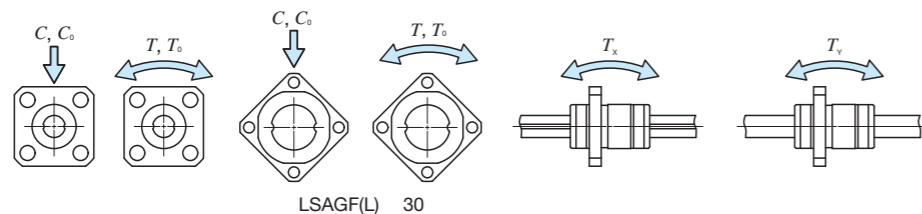

Example of identification number of assembled set

Model code Dimensions Part code Preload symbol Classification symbol Interchangeable code Supplemental code

MAGF **T** **12** **C2** **R300** **T1** **H** **/N**

① ② ③ ④ ⑤ ⑥ ⑦ ⑧ ⑨ ⑩

① Model MAGF Flange type LSAGF	④ Size 10, 12, 15, 20, 25, 30	⑦ Preload amount No symbol Standard T1 Light preload	⑩ Interchangeable No symbol Non-interchangeable specification S1 S1 specification S2 S2 specification
② Length of external cylinder No symbol Standard L Long	⑤ Number of external cylinders (2)	⑧ Accuracy class No symbol Ordinary H High P Precision	⑨ Special specification BS, N, OH, Q, RE, S, Y
③ Spline shaft shape No symbol Solid shaft T Hollow shaft	⑥ Length of spline shaft (300 mm)		